



HIGH QUALITY TOOLS

PROMO 2021

VALIDITÀ: 01.01.21 – 31.12.21

SET FRESE APKT 1003 TOP LINE

SET 740W W

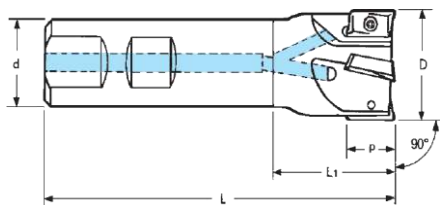

Profi-box Fresa+ Inserti

1 Fresa ad inserti lubrorefrigerata per spallamenti a 90° con codolo Cilindrico + 20 inserti

DIAMETRI DISPONIBILI A CATALOGO:

Articolo-Nr.	D	d	L	L ₁	p	z
740W W D10/1	10	16	80	24	10	1
740W W D11/1	11	16	80	24	10	1
740W W D12/1	12	16	80	24	10	1
740W W D13/1	13	16	80	24	10	1
740W W D14/1	14	16	80	24	10	1
740W W D15/2	15	16	85	25	10	2
740W W D15,7/2	15,7	16	85	25	10	2
740W W D16/2	16	16	85	25	10	2
740W W D17/2	17	16	85	25	10	2
740W W D18/2	18	20	85	25	10	2
740W W D19,5/3	19,5	20	90	25	10	3
740W W D19,7/3	19,7	20	90	25	10	3
740W W D20/3	20	20	90	25	10	3
740W W D22/3	22	25	95	25	10	3
740W W D24,7/4	24,7	25	95	25	10	4
740W W D25/4	25	25	95	25	10	4
740W W D32/5	32	25	95	31	10	5

SET 740W W D16

Prezzo Promo € 149,- NETTO/SET	1PC 740W W D16/2 20PCS APKT 1003 PDER-SK300
---	--

SET 740W W D20

Prezzo Promo € 159,- NETTO/SET	1PC 740W W D20/3 20PCS APKT 1003 PDER-SK300
---	--

SET 740W W D25

Prezzo Promo € 169,- NETTO/SET	1PC 740W W D25/4 20PCS APKT 1003 PDER-SK300
---	--

SET 740M W

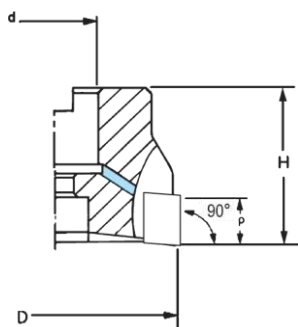

DIAMETRI DISPONIBILI A CATALOGO:

Articolo-Nr.	D	d	H	p	z
740M W D40/6	40	16	40	10	6
740M W D50/7	50	22	40	10	7
740M W D63/8	63	22	40	10	8
740M W D80/11	80	27	50	10	11
740M W D100/12	100	32	50	10	12



Profi-box Fresa+ Inserti

1 Fresa ad inserti lubrorefrigerata per spallamenti a 90° con attacco a manicotto + 20 inserti

SET 740M W D40

Prezzo Promo € 249,- NETTO/SET	1PC 740M W D40/6 20PCS APKT 1003 PDER-SK300
---	--

SET 740M W D50

Prezzo Promo € 259,- NETTO/SET	1PC 740M W D50/7 20PCS APKT 1003 PDER-SK300
---	--

SET 740M W D63

Prezzo Promo € 269,- NETTO/SET	1PC 740M W D63/8 20PCS APKT 1003 PDER-SK300
---	--

SET FRESE APKT 1003 TOP LINE

SET 730W W D25

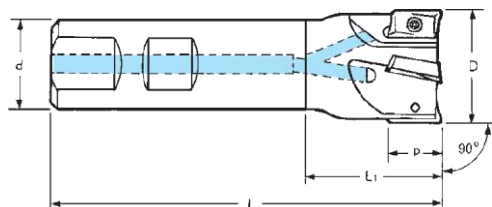

Profi-box Fresa + inserti

1 Fresa ad inserti lubrorefrigerata per spallamenti a 90° con codolo cilindrico + 20 inserti

DIAMETRI DISPONIBILI A CATALOGO:

Articolo-Nr.	D	d	L	L ₁	p	z
730W W D25/2	25	25	100	44	17	2
730W W D32/3	32	32	110	50	17	3
730W W D40/4	40	32	115	45	17	4
730W WL D22/2	22	20	200	145	17	2
730W WL D25/2	25	25	200	140	17	2
730W WL D32/3	32	32	200	140	17	3
730W WL D40/4	40	32	200	60	17	4

SET 730W W D25

Prezzo Promo	1PC	730W W D25/2
€ 179,-	20PCS	APKT 1604 PDER-SK300
NETTO/SET		

SET 730M W

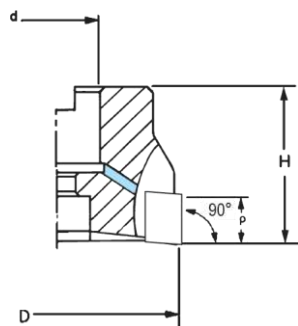

Profi-box Fresa+ Inserti

1 Fresa ad inserti lubrorefrigerata per spallamenti a 90° con attacco a manicotto + 20 inserti

DIAMETRI DISPONIBILI A CATALOGO:

Articolo-Nr.	D	d	H	p	z
730M W D40/4	40	16	40	17	4
730M W D50/5	50	22	40	17	5
730M W D63/6	63	22	40	17	6
730M W D80/7	80	27	50	17	7
730M W D100/8	100	32	50	17	8
730M W D125/9	125	40	63	17	9
730M D160/10	160	40	63	17	10
730M D200/12	200	60	63	17	12
730M D250/16	250	60	63	17	16

SET 730M W D40

Prezzo Promo	1PC	730M W D40/4
€ 239,-	20PCS	APKT 1604 PDER-SK300
NETTO/SET		

SET 730M W D50

Prezzo Promo	1PC	730M W D50/5
€ 249,-	20PCS	APKT 1604 PDER-SK300
NETTO/SET		

SET 730M W D63

Prezzo Promo	1PC	730M W D63/6
€ 259,-	20PCS	APKT 1604 PDER-SK300
NETTO/SET		

SET FRESE WNEU TOP LINE

SET 830W W

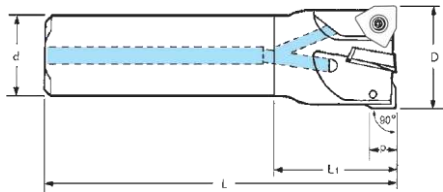

DIAMETRI DISPONIBILI A CATALOGO:

Articolo-Nr.	D	d	L	L ₁	p	z
830W W D20/3	20	20	90	40	4	3
830W W D25/4	25	25	100	44	4	4
830W W D32/5	32	32	110	50	4	5
830W WL D20/3	20	20	150	40	4	3
830W WL D25/4	25	25	170	50	4	4
830W WL D32/5	32	32	195	70	4	5



Profi-box Fresa+Inserti

Fresa ad inserti (geometria negativa)
lubrificata per spallamenti a 90°
con codolo cilindrico + 20 inserti

SET 830W W D20

Prezzo Promo € 229,- NETTO/SET	1PC 20PCS	830W W D20/3 WNEU 040308-MM K300
---	--------------	-------------------------------------

SET 830W W D25

Prezzo Promo € 239,- NETTO/SET	1PC 20PCS	830W W D25/4 WNEU 040308-MM K300
---	--------------	-------------------------------------

SET 830M W

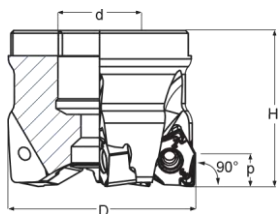

DIAMETRI DISPONIBILI A CATALOGO:

Articolo-Nr.	D	d	H	p	z
830M W D32/6	32	16	40	4	6
830M W D40/6	40	16	40	4	6
830M W D50/8	50	22	40	4	8
830M W D63/9	63	22	40	4	9



Profi-box Fresa+Inserti

Fresa ad inserti (geometria negativa)
lubrificata per spallamenti a 90°
con attacco a manicotto + 20 inserti

Prezzo Promo € 389,- NETTO/SET	1PC 20PCS	830M W D32/6 WNEU 040308-MM K300
---	--------------	-------------------------------------

SET 830M W D40

Prezzo Promo € 399,- NETTO/SET	1PC 20PCS	830M W D40/6 WNEU 040308-MM K300
---	--------------	-------------------------------------

SET 830M W D50

Prezzo Promo € 409,- NETTO/SET	1PC 20PCS	830M W D50/8 WNEU 040308-MM K300
---	--------------	-------------------------------------

SET 835M W

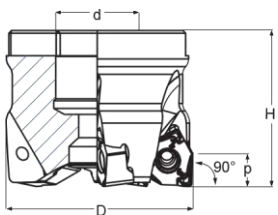

DIAMETRI DISPONIBILI A CATALOGO:

Articolo-Nr.	D	d	H	p	z
835M W D40/3	40	16	40	7	3
835M W D50/5	50	22	40	7	5
835M W D63/6	63	22	40	7	6
835M W D80/7	80	27	50	7	7
835M W D100/8	100	32	50	7	8
835M W D125/10	125	40	63	7	10
835M W D160/11	160	40	63	7	11
835M W D63F/7	63	22	40	7	7
835M W D80F/9	80	27	50	7	9
835M W D100F/10	100	32	50	7	10
835M W D125F/11	125	40	63	7	11
835M W D160F/12	160	40	63	7	12



Profi-box Fresa+Inserti

Fresa ad inserti (geometria negativa)
lubrificata per spallamenti a 90°
con attacco a manicotto + 20 inserti

Prezzo Promo € 389,- NETTO/SET	1PC 20PCS	835M W D50/5 WNEU 080608-MB K300
---	--------------	-------------------------------------

SET 835M W D63

Prezzo Promo € 399,- NETTO/SET	1PC 20PCS	835M W D63/6 WNEU 080608-MB K300
---	--------------	-------------------------------------

SET 835M W D80

Prezzo Promo € 409,- NETTO/SET	1PC 20PCS	835M W D80/7 WNEU 080608-MB K300
---	--------------	-------------------------------------

SET FRESE A SPIANARE SNMX-SNMU-ONMU TOP LINE

SET 810M W SN

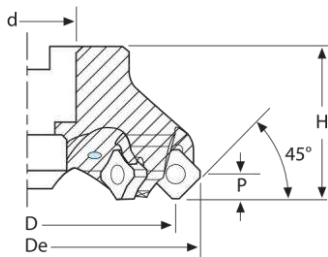

Profi-box Fresa+Inserti

Fresa per spianatura a 45° a passo differenziato e 20 suoi inserti

DIAMETRI DISPONIBILI A CATALOGO:

Articolo-Nr.	D	De	d	H	p	z
810M W D50/4	50	63	22	40	6	4
810M W D63/6	63	76	22	40	6	6
810M W D80/7	80	93	27	50	6	7
810M W D100/8	100	113	32	50	6	8
810M W D125/10	125	138	40	63	6	10
810M W D160/12	160	173	40	63	6	12
810M W D200/14	200	213	60	63	6	14
810M W D250/16	250	263	60	63	6	16

SET 810M W D50 SN

Prezzo Promo	1PC	810M W D50/4
€ 289,-	10PCS	SNMX 1206ANN-MB1 K300
NETTO/SET	10PCS	SNMU 1206ANER K300

SET 810M W D63 SN

Prezzo Promo	1PC	810M W D63/6
€ 299,-	10PCS	SNMX 1206ANN-MB1 K300
NETTO/SET	10PCS	SNMU 1206ANER K300

SET 810M W D80 SN

Prezzo Promo	1PC	810M W D80/7
€ 319,-	10PCS	SNMX 1206ANN-MB1 K300
NETTO/SET	10PCS	SNMU 1206ANER K300

SET 810M W SN-ON

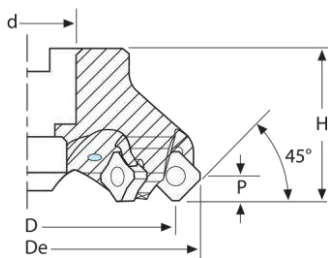

Profi-box Fresa+Inserti

Fresa per spianatura a 45° a passo differenziato + 20 inserti

DIAMETRI DISPONIBILI A CATALOGO:

Articolo-Nr.	D	De	d	H	p	z
810M W D50/4	50	63	22	40	6	4
810M W D63/6	63	76	22	40	6	6
810M W D80/7	80	93	27	50	6	7
810M W D100/8	100	113	32	50	6	8
810M W D125/10	125	138	40	63	6	10
810M W D160/12	160	173	40	63	6	12
810M W D200/14	200	213	60	63	6	14
810M W D250/16	250	263	60	63	6	16

SET 810M W D50 SN-ON

Prezzo Promo	1PC	810M W D50/4
€ 289,-	10PCS	SNMU 1206ANER K300
NETTO/SET	10PCS	ONMU 1205ANN-MB K300

SET 810M W D63 SN-ON

Prezzo Promo	1PC	810M W D63/6
€ 299,-	10PCS	SNMU 1206ANER K300
NETTO/SET	10PCS	ONMU 1205ANN-MB K300

SET 810M W D80 SN-ON

Prezzo Promo	1PC	810M W D80/7
€ 319,-	10PCS	SNMU 1206ANER K300
NETTO/SET	10PCS	ONMU 1205ANN-MB K300

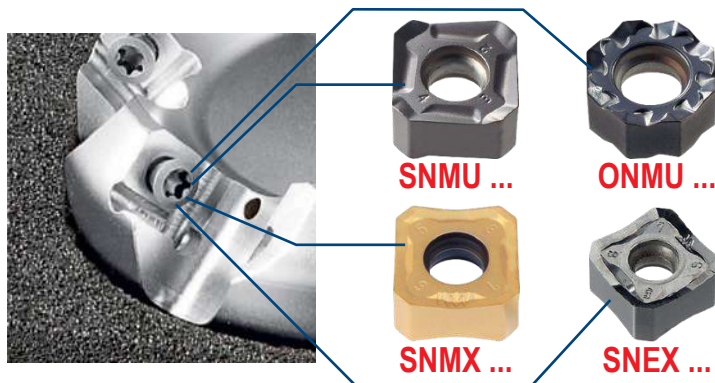

**SULLA STESSA SEDE INSERTO SI POSSONO MONTARE DUE TIPOLOGIE DI INSERTI CON GEOMETRIA NEGATIVA :
4 TAGLIENTI E 8 TAGLIENTI**

FRESE APKT ECO LINE

ART. 740W ECO

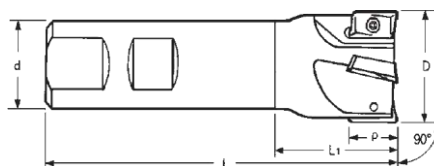

Articolo-Nr.	Misure (mm.)											NETTO/STK
	D	d	L	L ₁	p	z						
740W D16/2 ECO	16	16	85	37	10	2	APHT APHX APKT 1003 ...				0,130	€ 49,-
740W D20/3 ECO	20	20	90	40	10	3		VT25	BT08		0,200	€ 59,-
740W D25/4 ECO	25	25	105	49	10	4					0,340	€ 69,-

ART. 740M ECO

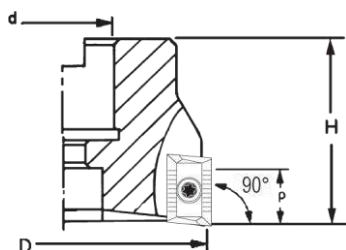

ART. 730M ECO



Articolo-Nr.	Misure (mm.)									NETTO/STK
	D	d	H	p	z					
740M D40/6 ECO	40	16	40	10	6	APHT APHX APKT 1003...	VT25	BT08	0,270	€ 99,-
740M D50/7 ECO	50	22	40	10	7				0,430	€ 109,-
730M D40/4 ECO	40	16	40	17	4	APHT APHX APKT 1604 ...			0,210	€ 105,-
730M D50/5 ECO	50	22	40	17	5		VT40	BT15	0,290	€ 113,-
730M D63/6 ECO	63	22	40	17	6				0,530	€ 120,-

FRESE SEKT ECO LINE

ART. 600 M ECO

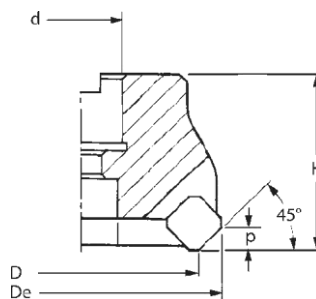

Articolo-Nr.	Misure (mm.)											NETTO/STK
	D	De	d	H	p	z						
600M W D50-12/4	50	63	22	48	6	4	SEHT SEHX SEKT 1204...				0,480	€ 89,-
600M W D63-12/5	63	76	22	48	6	5		VT50	BT20		0,760	€ 104,-
600M W D80-12/6	80	93	27	50	6	6					1,270	€ 135,-
600M W D100-12/6	100	113	32	50	6	6					1,790	€ 149,-

SET FRESE APKT/SEKT ECO LINE

SET 740W ECO



SET 740W D16 ECO

Prezzo Promo € 139,- NETTO/SET	1PC 740W D16/2 ECO 20PCS APKT 1003PDR-MK400
---	--

SET 740W D20 ECO

Prezzo Promo € 149,- NETTO/SET	1PC 740W D20/3 ECO 20PCS APKT 1003PDR-MK400
---	--

SET 740W D25 ECO

Prezzo Promo € 159,- NETTO/SET	1PC 740W D25/4 ECO 20PCS APKT 1003PDR-MK400
---	--

SET 740M ECO



SET 740M D40 ECO

€ 165,- NETTO/SET	1PC 740M D40/6 ECO 20PCS APKT 1003PDR-MK400
-----------------------------	--

SET 740M D50 ECO

€ 170,- NETTO/SET	1PC 740M D50/7 ECO 20PCS APKT 1003PDR-MK400
-----------------------------	--

SET 730M ECO



SET 730M D40 ECO

Prezzo Promo € 165,- NETTO/SET	1PC 730M D40/4 ECO 20PCS APKT 1604PDR-MK400
---	--

SET 730M D50 ECO

Prezzo Promo € 175,- NETTO/SET	1PC 730M D50/5 ECO 20PCS APKT 1604PDR-MK400
---	--

SET 730M D63 ECO

Prezzo Promo € 195,- NETTO/SET	1PC 730M D63/6 ECO 20PCS APKT 1604PDR-MK400
---	--

SET 600M ECO

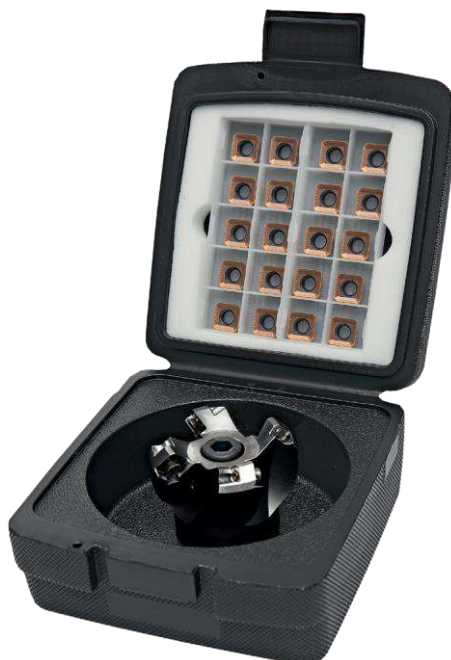

SET 600M D50 ECO

Prezzo Promo € 236,- NETTO/SET	1PC 600M D50-12/4 ECO 20PCS SEKT 1204 AFTN K400
---	--

SET 600M D63 ECO

Prezzo Promo € 251,- NETTO/SET	1PC 600M D63-12/5 ECO 20PCS SEKT 1204 AFTN K400
---	--

SET 600M D80 ECO

Prezzo Promo € 282,- NETTO/SET	1PC 600M D80-12/6 ECO 20PCS SEKT 1204 AFTN K400
---	--

SET FRESA AD INSERTI (TCMX) PER SMUSSARE CENTRARE E SCANALATURE A V

SET 311W W

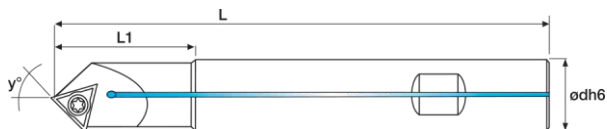

Profi-box Fresa+Inserti

1 Fresa lubrorefrigerata + 4 inserti, per esecuzione di smussi scanalature a V e centrature, con attacco cilindrico weldon.

DIAMETRI DISPONIBILI A CATALOGO:

Articolo-Nr.	Ø dh6	L	L1	Y°	Z	D _{min}	D _{max}
311.020 WW	20	115	40	45°	1	0,4	20
311.020 WWL	20	150	60	45°	1	0,4	20
311.020 WWXL	20	200	80	45°	1	0,4	20

SET 311W W

Prezzo Promo

€ 149,-
NET/SET

1PC 311.020WW
4PCS TCMX 16T3ZR TIN

NEW

SET FRESA AD INSERTI (SEEX) PER SMUSSARE CENTRARE E SCANALATURE A V

SET 160 W

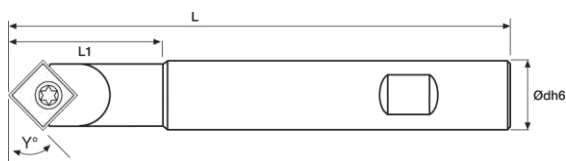

Profi-box Fresa+Inserti

1 Fresa + 5 inserti con attacco cilindrico weldon, per esecuzione di smussi e scanalature a V, per centrature dal pieno, sbavatura di fori, asole e tasche.

DIAMETRI DISPONIBILI A CATALOGO:

Articolo-Nr.	Ø dh6	DS	L	L1	Y°	Z	D _{min}	D _{max}
160.45 W	16	0,8	120	40	45°	1	0,8	17
160.30 W	16	0,8	120	40	30°	1	0,8	21

SET 160 W 45°

Prezzo Promo

€ 149,-
NET/SET

1PC 160.45 W
5PCS SEEX 12T408 TIN

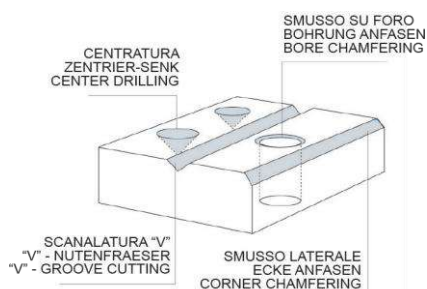

SET FRESE A INSERTI (TCMT) PER SVASATURE

SET 300W W SET 310W W

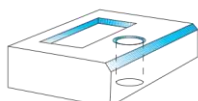
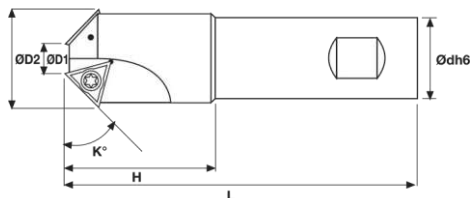

Profi-box Frese+ins. su richiesta

2 Frese a inserti lubrorefrigerate per TCMT 1102 ... per esecuzione di smussi e svasature, con attacco cilindrico e weldon.

DIAMETRI DISPONIBILI A CATALOGO:

Articolo-Nr.	ØD1	ØD2	L	H	Ødh6	Y°	Z
300.016 WW	1,2	16	70	20	12	45°	1
300.021 WW	6,2	21	90	35	20	45°	2
300.032 WW	10,4	32,5	100	42	25	45°	2

Articolo-Nr.	ØD1	ØD2	L	H	Ødh6	Y°	Z
310.016 WW	5,4	16	70	20	12	60°	1
310.027 WW	15,8	26	90	35	20	60°	2
310.032 WW	20	35	100	39	25	60°	2

SET 300W W - 45° TCMT 1102...

Prezzo Promo	1PC	300.016W
€ 139,-	1PC	300.021W
NET/SET		

SET 310W W - 60° TCMT 1102...

Prezzo Promo	1PC	310.016W
€ 139,-	1PC	310.027W
NET/SET		

SET FRESE A INSERTI (TCGX) PER SVASATURE A 45°

SET 7745

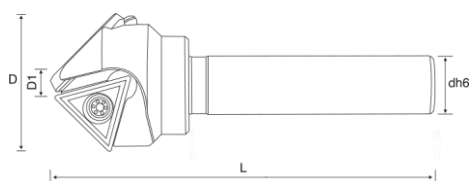

DIAMETRI DISPONIBILI A CATALOGO:

Articolo-Nr.	D	D1	L	dh6	Y°	Z
7745VT16-C12-0525	25	5	78	12	45°	1
7745VT16-C12-2545	45	25	78	12	45°	1

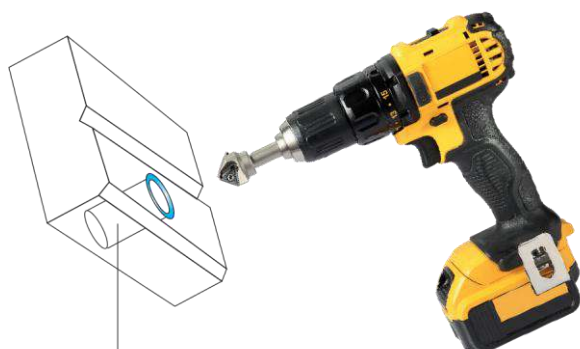

SMUSSO SU FORO BOHRUNG ANFASEN BORE CHAMFERING



Profi-box Fresa+Inserti

1 Fresa a inserti per TCGX ... per esecuzione di svasature di fori, con attacco cilindrico. Dotata di un pattino in M.D. che permette alla fresa di rimanere in un posizione annullando le vibrazioni.

SET 7745

Prezzo Promo	1PC	7745VT16-C12-0525
€ 149,-	4PCS	TCGX 163504 K400
NET/SET		

POSSIBILITA' DI UTILIZZO SU TRAPANI A CALONNA MA ANCHE SU TRAPANO A MANO!

PORTA INSERTI LUBROREFRIGERANTI PER TORNITURA ESTERNA POSITIVA CON ATTACCO G1/8 TOP LINE

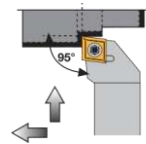
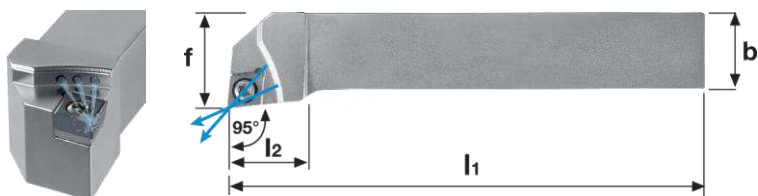

SCLCR/L Stelo in acciaio | *Stahlschaft* | Steelshank

Articolo-Nr.	Dimensioni (mm.)						CCMT CCGT 09T3...	US1111	GBS1111	SS1111	BT15	kg	STOCK	PrezzoPromo NET/PC
	h ₁	h ₂	b	l ₁	l ₂	f								
SCLCR/L1616H09-1KG1/8	16	16	16	100	17	20						0,235		€ 139,-
SCLCR/L2020K09-1KG1/8	20	20	20	125	17	25						0,420		€ 145,-
SCLCR/L2525M12-1KG1/8	25	25	25	150	20	32	CCMT CCGT 1204...	US1221	GBS1221	SS1221		0,770		€ 149,-

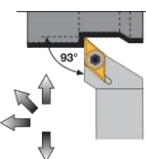
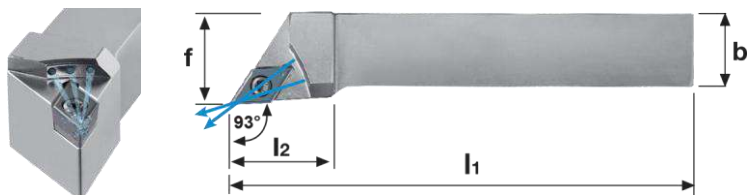

SDJCR/L Stelo in acciaio | *Stahlschaft* | Steelshank

Articolo-Nr.	Dimensioni (mm.)						DCMT DCGT 11T3...	US2311	GBS1111	SS1111	BT15	kg	STOCK	PrezzoPromo NET/PC
	h ₁	h ₂	b	l ₁	l ₂	f								
SDJCR/L1616H11-1KG1/8	16	16	16	100	20	20						0,230		€ 139,-
SDJCR/L2020K11-1KG1/8	20	20	20	125	24	25						0,408		€ 145,-
SDJCR/L2525M11-1KG1/8	25	25	25	150	27	32						0,735		€ 149,-

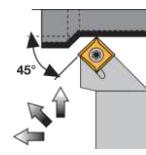
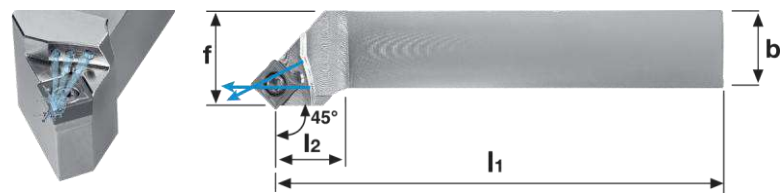

SSSCR/L Stelo in acciaio | *Stahlschaft* | Steelshank

Articolo-Nr.	Dimensioni (mm.)						SCMT SCGT 09T3...	US4111	GBS1111	SS1111	BT15	kg	STOCK	PrezzoPromo NET/PC
	h ₁	h ₂	b	l ₁	l ₂	f								
SSSCR/L1616H09-1KG1/8	16	16	16	100	20	20						0,235		€ 139,-
SSSCR/L2020K09-1KG1/8	20	20	20	125	20	25						0,420		€ 145,-
SSSCR/L2525M12-1KG1/8	25	25	25	150	25	32	SCMT SCGT 1204...	US4221	GBS1221	SS1221	BT15	0,770		€ 149,-

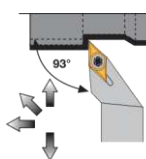
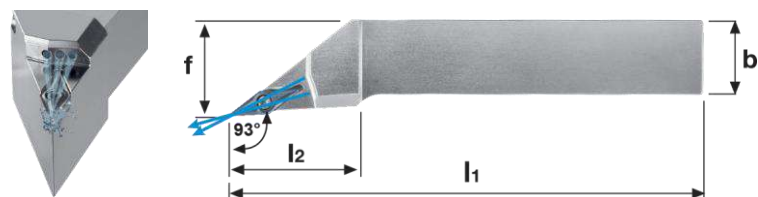

SVJCR/L Stelo in acciaio | *Stahlschaft* | Steelshank

Articolo-Nr.	Dimensioni (mm.)						VCMT VCGT 1103...	US6522	GBS1111	SS1111	BT15	kg	STOCK	PrezzoPromo NET/PC
	h ₁	h ₂	b	l ₁	l ₂	f								
SVJCR/L1616H11-1KG1/8	16	16	16	100	21,5	20						0,203		€ 139,-
SVJCR/L2020K11-1KG1/8	20	20	20	125	23	25						0,373		€ 145,-
SVJCR/L2020K16-1KG1/8	20	20	20	125	29,5	25	VCMT VCGT 1604...	US6522	GBS1111	SS1111	BT15	0,380		€ 145,-
SVJCR/L2525M16-1KG1/8	25	25	25	150	32,5	32						0,677		€ 149,-

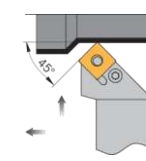
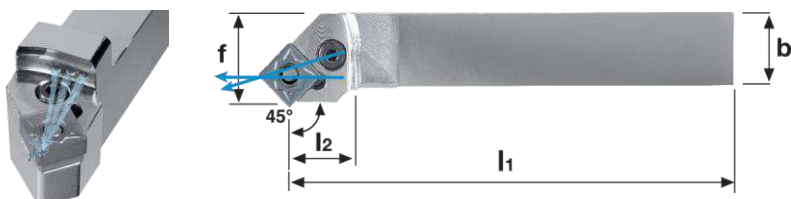

PSSNR/L Stelo in acciaio | *Stahlschaft* | Steelshank

Articolo-Nr.	Dimensioni (mm.)						SNMG1204...	UP5112	HP1111	SP1111	RP1111	MP1111	kg	STOCK	PrezzoPromo NET/PC
	h ₁	h ₂	b	l ₁	l ₂	f									
PSSNR/L2020K12-1KG1/8	20	20	20	125	29,4	25							0,430		€ 149,-
PSSNR/L2525M12-1KG1/8	25	25	25	150	29,3	32							0,760		€ 159,-

PORTA INSERTI LUBROREFRIGERANTI PER TORNITURA ESTERNA NEGATIVA ECONOMY LINE

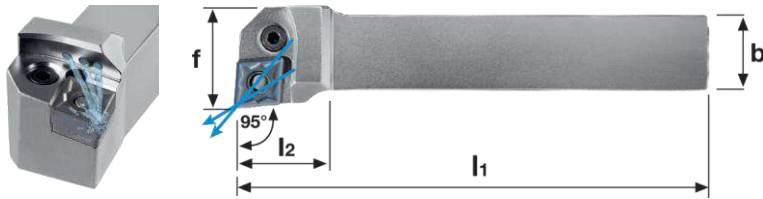

PCLNR/L Stelo in acciaio | *Stahlschaft* | Steelshank

Articolo-Nr.	Dimensioni (mm.)						CNMG 1204...	UP1111	HP 1111	SP 1111	RP1111	MP1111	kg	STOCK	PrezzoPromo NET/PC
	h ₁	h ₂	b	l ₁	l ₂	f									
PCLNR/L1616H12-IKECO	16	16	16	100	26,1	20							0,254		• € 101,-
PCLNR/L2020K12-IKECO	20	20	20	125	27,4	25							0,428		• € 102,-
PCLNR/L2525M12-IKECO	25	25	25	150	28	32							0,751		• € 104,-

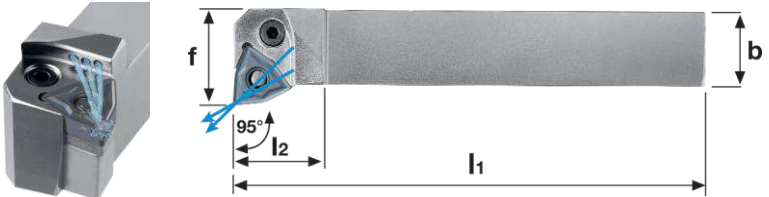

PVLNR/L Stelo in acciaio | *Stahlschaft* | Steelshank

Articolo-Nr.	Dimensioni (mm.)						WNMG0804...	UP71011	HP1111	SP 1111	RP1111	MP1111	kg	STOCK	PrezzoPromo NET/PC
	h ₁	h ₂	b	l ₁	l ₂	f									
PVLNR/L2020K08-IKECO	20	20	20	125	25	25							0,420		• € 102,-
PVLNR/L2525M08-IKECO	25	25	25	150	25	32							0,767		• € 104,-

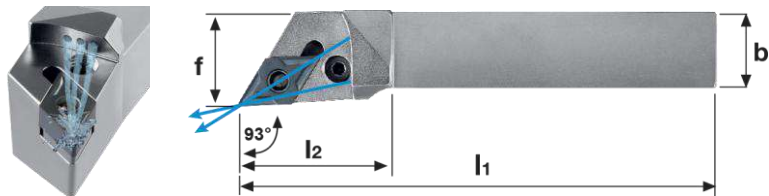

PDJNR/L Stelo in acciaio | *Stahlschaft* | Steelshank

Articolo-Nr.	Dimensioni (mm.)						DNMG 1506...	UP2421	HP2421	SP1111	RP1111	MP1111	kg	STOCK	PrezzoPromo NET/PC
	h ₁	h ₂	b	l ₁	l ₂	f									
PDJNR/L2020K15-IKECO	20	20	20	125	30	25							0,411		• € 102,-
PDJNR/L2525M15-IKECO	25	25	25	150	30	32							0,737		• € 104,-

Dreifache Anschlussmöglichkeit für zielgerichtete Kühlung

Bessere Oberflächengüte
und Maßhaltigkeit der Bauteile

Zielgerichtete Kühlung
für höhere Prozesssicherheit durch
bis zu 70% höhere Standzeiten

Anschlussmöglichkeit
für direkte Übergabe über
VDI-Halter mit Kühlmittelübergabe

Passend
für alle gängigen VDI-Halter mit
Kühlmittelübergabe

Höhere Produktivität
durch bis zu 50% höhere
Schnittgeschwindigkeiten

Anschlussmöglichkeit
über Schlauchverbindung
an der Kugelspritzdüse

Reduzierung
der Werkzeug-
und Bearbeitungskosten

Anschlussmöglichkeit
über Schlauchverbindung
an der Rückseite

SET BARENI IN METALLO DURO E HSS

SET E SCLCR/L 06

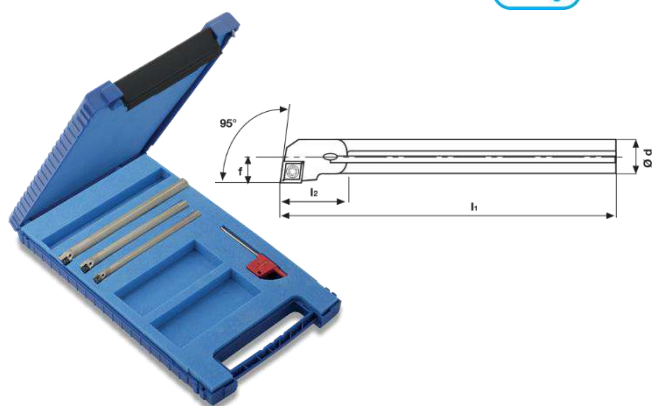

SET E SCLCR/L 06

Aktionspreis	1PC	E08K	SCLCR/L 06
€ 269,-	1PC	E10K	SCLCR/L 06
NETTO/SET	1PC	E12M	SCLCR/L 06

DIAMETRI DISPONIBILI A CATALOGO:

d	l ₁	l ₂	f	D _{min}
4	90	10	2,5	5
5	100	10	3	6
6	110	10	3,5	7
8	125	10	5	10
10	125	10	6	12
12	150	10	8	14
16	200	16	10	18
20	250	16	12	23
25	250	16	15	30
32	350	26	22	39

SET AH SCLCR/L 06

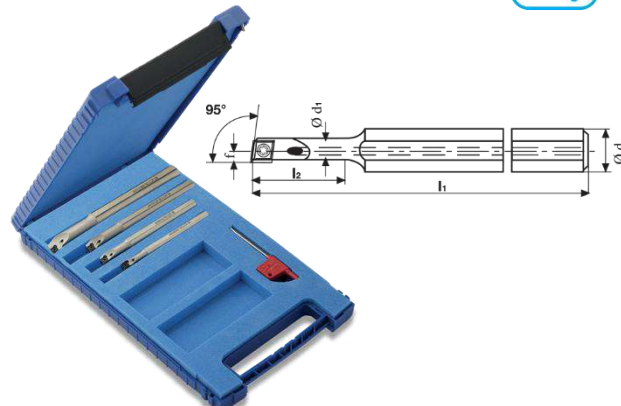

SET AH SCLCR/L 06

Aktionspreis	1PC	AH0608H	SCLCR/L 06
€ 259,-	1PC	AH0810J	SCLCR/L 06
NETTO/SET	1PC	AH1012K	SCLCR/L 06
	1PC	AH1216M	SCLCR/L 06

DIAMETRI DISPONIBILI A CATALOGO:

d	d ₁	l ₁	l ₂	f	D _{min}
8	6	100	21,5	4,2	8
10	8	110	27	6	11
12	10	125	32,5	7	13
16	12	150	42	9	16

SET E SDUCR/L 07

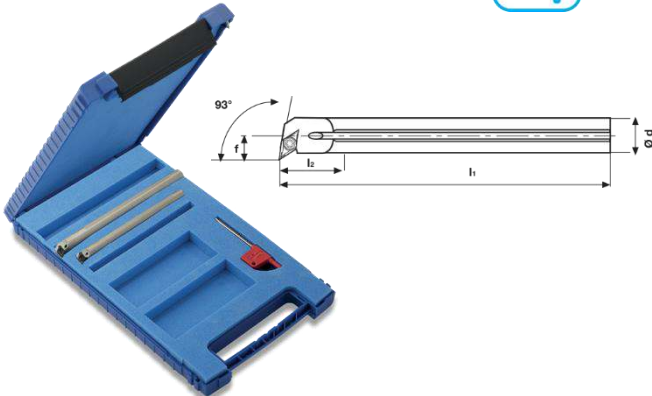

SET E SDUCR/L 07

Aktionspreis	1PC	E10K	SDUCR/L 07
€ 229,-	1PC	E12M	SDUCR/L 07
NETTO/SET			

d	l ₁	l ₂	f	D _{min}
8	125	10	7,5	12,5
10	125	10	7	13
12	150	12,5	9	16
16	200	16,5	11	20
20	250	20,5	12,5	25
25	250	26	16	32

DIAMETRI DISPONIBILI A CATALOGO:

SET AH SDUCR/L 07

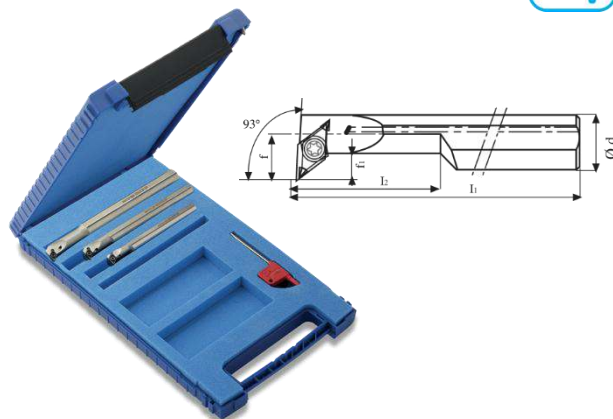

SET AH SDUCR/L 07

Aktionspreis	1PC	AH0810H	SDUCR/L 07
€ 229,-	1PC	AH1012K	SDUCR/L 07
NETTO/SET	1PC	AH1216M	SDUCR/L 07

d	l ₁	l ₂	f	f ₁	D _{min}
10	100	22	7	5	12,5
12	125	28	9	5	15,5
16	150	36	11	5	19,5

DIAMETRI DISPONIBILI A CATALOGO:

SET BARENI IN ACCIAIO

SET A SCLCR/L 06



SET A SCLCR/L 06

Prezzo Promo € 129,- NET/SET	1PC	A0608H	SCLCR/L 06
	1PC	A0810J	SCLCR/L 06
	1PC	A1012K	SCLCR/L 06
	1PC	A1216M	SCLCR/L 06

SET S SCLCR 06



SET S SCLCR 06

Prezzo Promo € 119,- NET/SET	1PC	S0608H	SCLCR 06
	1PC	S0810J	SCLCR 06
	1PC	S1012K	SCLCR 06
	1PC	S1216M	SCLCR 06

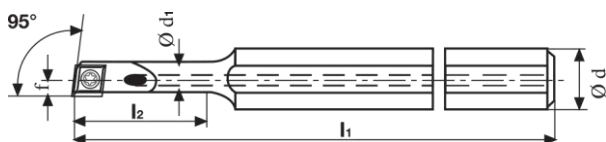

d	d ₁	l ₁	l ₂	f	D _{min}
8	6	100	21,5	4,2	8
10	8	110	27	6	11
12	10	125	32,5	7	13
16	12	150	42	9	16

SET A SDUCR/L 07



SET A SDUCR/L 07

Prezzo Promo € 129,- NET/SET	1PC	A0810H	SDUCR/L07
	1PC	A1012K	SDUCR/L 07
	1PC	A1216M	SDUCR/L 07

SET S SDUCR 07



SET S SDUCR 07

Prezzo Promo € 119,- NET/SET	1PC	S0810H	SDUCR 07
	1PC	S1012K	SDUCR 07
	1PC	S1216M	SDUCR 07

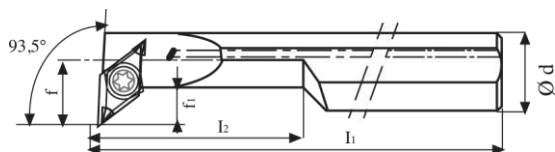

d	l ₁	l ₂	f	f ₁	D _{min}
10	100	22,5	6,5	4,4	12,5
12	125	27,5	9	5,9	15,5
16	150	40,5	11	4,9	18

SET FRESE IN METALLO DURO

SET PE TISIN



Profi-box Frese in M.D.

4 Frese a candela in metallo duro 3-/4
Taglienti a 45°ora nel nuovo PROFI-BOX!

SET PE 3T TISIN 45°

Prezzo Promo	1PC PE0603 TISIN	SINGLE € 12,00 NETTO/STK
€ 89,-	1PC PE0803 TISIN	SINGLE € 22,00 NETTO/STK
NETTO/SET	1PC PE1003 TISIN	SINGLE € 32,00 NETTO/STK
	1PC PE1203 TISIN	SINGLE € 42,00 NETTO/STK

SET PE 4T TISIN 45°

Prezzo Promo	1PC PE0604 TISIN	SINGLE € 12,00 NETTO/STK
€ 89,-	1PC PE0804 TISIN	SINGLE € 22,00 NETTO/STK
NETTO/SET	1PC PE1004 TISIN	SINGLE € 32,00 NETTO/STK
	1PC PE1204 TISIN	SINGLE € 42,00 NETTO/STK

SET MPE/MSE 50



Profi-box Frese in M.D.

50 Frese a candela in metallo duro
3- Taglienti a 45°
oppure
4- Taglienti a 35°
Ora nel nuovo PROFI-BOX!

SET MPE 3T TISIN 45°

Prezzo Promo	10PCS MPE0103 TISIN	SINGLE € 9,90 NETTO/STK
€ 269,-	10PCS MPE0153 TISIN	SINGLE € 9,90 NETTO/STK
NETTO/SET	10PCS MPE0203 TISIN	SINGLE € 9,90 NETTO/STK
	10PCS MPE0303 TISIN	SINGLE € 9,90 NETTO/STK
	10PCS MPE0403 TISIN	SINGLE € 9,90 NETTO/STK

SET MSE 4T/50 TISIN 35°

Prezzo Promo	10PCS MSE0104 TISIN	SINGLE € 9,90 NETTO/STK
€ 269,-	10PCS MSE0154 TISIN	SINGLE € 9,90 NETTO/STK
NETTO/SET	10PCS MSE0204 TISIN	SINGLE € 9,90 NETTO/STK
	10PCS MSE0304 TISIN	SINGLE € 9,90 NETTO/STK
	10PCS MSE0404 TISIN	SINGLE € 9,90 NETTO/STK

SET MSB 50



Profi-box Frese in M.D.

50 Frese sferiche in metallo duro
2- Taglienti a 35°
Ora nel nuovo PROFI-BOX!

SET MSB 2T/50 TISIN 35°

Prezzo Promo	10PCS MSB0102 TISIN	SINGLE € 14,90 NETTO/STK
€ 379,-	10PCS MSB0152 TISIN	SINGLE € 14,90 NETTO/STK
NETTO/SET	10PCS MSB0202 TISIN	SINGLE € 14,90 NETTO/STK
	10PCS MSB0302 TISIN	SINGLE € 14,90 NETTO/STK
	10PCS MSB0402 TISIN	SINGLE € 14,90 NETTO/STK

INSERTI / WENDEPLATTEN / INSERTS

CODICE ORDINE Bestell-Nr. Order No.	Figura Form Figure	-Dimensioni A-bmessungen -Dimensions-					Denominazione Bezeichnung Designation	Min. 100 pz./St./pcs.	Min. 300 pz./St./pcs.
APKT... PDR-M		10	6,7	3,5	3,2	0,5	APKT 1003 PDR-M K400	€ 4,50 netto/Stk	€ 3,70 netto/Stk
		16,3	9,5	5,26	4,4	0,9	APKT 1604 PDR-M K400	€ 5,40 netto/Stk	€ 4,50 netto/Stk
APKT... PDER-S		10,5	6,7	3,5	2,8	0,4	APKT 1003 PDER-S K300	€ 6,00 netto/Stk	€ 5,20 netto/Stk
		17	9,5	5,30	4,5	0,8	APKT 1604 PDER-S K300	€ 6,90 netto/Stk	€ 6,00 netto/Stk
SEEX		12,25	12,25	5,25	4,8	0,8	SEEX 12T408 TIN	€ 16,50 netto/Stk	€ 15,80 netto/Stk
SEKT		12,7	12,7	4,76	5,5	-	SEKT 1204 AFTN K400	€ 7,40 netto/Stk	€ 6,60 netto/Stk
SNMU		12,7	2,5	6,9	5,4	0,8	SNMU 1206 ANER K300	€ 10,50 netto/Stk	€ 9,70 netto/Stk
SNMX 1206...MB1		12,7	2,5	6,4	5,2	2,36	SNMX 1206 ANN-MB1 K300	€ 10,50 netto/Stk	€ 9,70 netto/Stk
TCGX		16,5	9,52	3,3	4,4	0,4	TCGX 163504 K400	€ 14,20 netto/Stk	€ 13,50 netto/Stk
TCMX		16,5	9,52	3,97	4,4	0,4	TCMX 16T3 ZR TIN	€ 13,50 netto/Stk	€ 12,80 netto/Stk
WNEU...		4	6,7	3,3	3,2	0,8	WNEU 040308-MM K300	€ 10,80 netto/Stk	€ 10,10 netto/Stk
		7,5	12,5	6,56	4,6	0,8	WNEU 080608-MB K300	€ 12,60 netto/Stk	€ 11,90 netto/Stk

